



SL-RL Series
LED Range Light
Installation & Service Manual



Version No.	Description	Date	Author	Approved
1.0	Manual Launch	September 2015	D. Tomaszewicz	
1.1	Spec Table	October 2015	M. Walker	
1.2	Trouble Shooting Guide updated ECR488	September 2016	Y. Chambers	
1.3	General Update	November 2016	A. Dixon	M. Nicholson

Table of Contents

Introduction	Page 4
Operating Principle	Page 4
Technology	Page 4
SL-RL Series	Page 5
Product Components	Page 8
Programming the Lantern: PC Configuration Tool	Page 9
Info Tab	Page 13
Operation mode Tab	Page 14
Flash Code	Page 16
Intensity	Page 17
Sensors	Page 18
AIS Report	Page 21
Programming the Lantern: IR Programmer	Page 22
Sealite IR Controller / Universal Remote Compatibility	Page 22
IR Programmer Functions	Page 23
Test Mode / Configure	Page 23
Normal Operation.....	Page 22
Read.....	Page 23
Flash Code.....	Page 24
Flash Code Numbers	Page 24
Intensity.....	Page 24
Battery Status.....	Page 25
Error / Acknowledge Indication.....	Page 26
Configuration Settings.....	Page 26
Operational Mode (Advanced Users).....	Page 27
Lantern Testing	Page 29
Lantern Installation	Page 29
Optional GPS Synchronisation	Page 35
Optional GSM Monitoring & Control System	Page 36
Maintenance & Servicing	Page 37
Trouble Shooting	Page 38
Appendix: Flash Codes	Page 41
Sealite LED Light Warranty	Page 45



Introduction

Congratulations! By choosing to purchase a Sealite lantern you have become the owner of one of the most advanced LED marine lanterns in the world.

Sealite Pty Ltd has been manufacturing lanterns for over 25 years, and particular care has been taken to ensure your lantern gives years of service.

As a commitment to producing the highest quality products for our customers, Sealite has been independently certified as complying with the requirements of ISO9001:2008 quality management system. Sealite lanterns comply with requirements of the US Coast Guard in 33 CFR part 66 for Private Aids To Navigation.

By taking a few moments to browse through this booklet, you will become familiar with the versatility of your lantern, and be able to maximise its operating function.

Operating Principle

A microprocessor drives an array of ultra bright LED's through a DC/DC converter, which enables the LED's to operate within the manufacturer's specifications.

On darkness, the microprocessor will initiate a program check and after approximately 1 minute begin flashing to the set Flash Character.

The flasher unit has a low current requirement to optimise its use with external battery power supply systems.

Technology

Sealite is the world's fastest growing manufacturer of marine aids to navigation. We employ leading mechanical, optical, hardware & software engineers to create innovative products to service the needs of our customers worldwide, and offer the widest range of solar-powered LED lanterns in the marketplace.

Electronics

Sealite employs leading in-house electronic engineers in the design and development of software and related circuitry. All individual electronic components are sourced directly by Sealite procurement staff ensuring that only the highest quality components are used in our products.

LED Technology

All marine lanterns use the latest advancements in LED (Light Emitting Diode) technology as a light source. The major advantage of LED's over traditional light sources is well established in that they typically have an operational life in excess of 100,000 hours, resulting in substantial savings to maintenance and servicing costs.

Precision Construction

Commitment to investing in the design and construction of injection-moulded parts including optic lenses, light bases and a range of other components ensures that all Sealite products are of a consistent & superior quality.

Optical Performance

Sealite manufactures a range of marine LED lenses moulded from multi-cavity dies. The company has superior in-house lens manufacturing capabilities to support outstanding optical performance.

Award-winning, Patented Technology

Several United States and Australian patent registrations are held on Sealite's range of innovative designs, with other regional patents pending in Canada, United Kingdom and Europe.

SL-RL Series LED Range Light

The Sealite SL-RL Series is a long range, high intensity range light designed to give vessels clear night and/or daytime navigation. A daytime range of over 5NM and a night-time range in excess of 23NM can be achieved.

Long Range LED Optics with Ultra-Low Power Consumption

Providing over 400,000cd, the Sealite Range Light is extraordinarily efficient and ideal for solar power systems.

Robust Construction

The Sealite Range Light is extremely robust and of high-quality construction. The unit is built from CNC machined marine grade aluminium alloy, subject to 7-stage powder coating. The IP67 rated enclosure offers maximum resistance to weather.

Advanced PC or IR Programming

Sealite's convenient PC Configuration Tool or IR programmer allows a host of features to be user set including;

- Multiple intensity settings
- 310 flash settings including custom character
- Adjustable on/off lux levels
- Low battery threshold
- GPS synchronisation offset

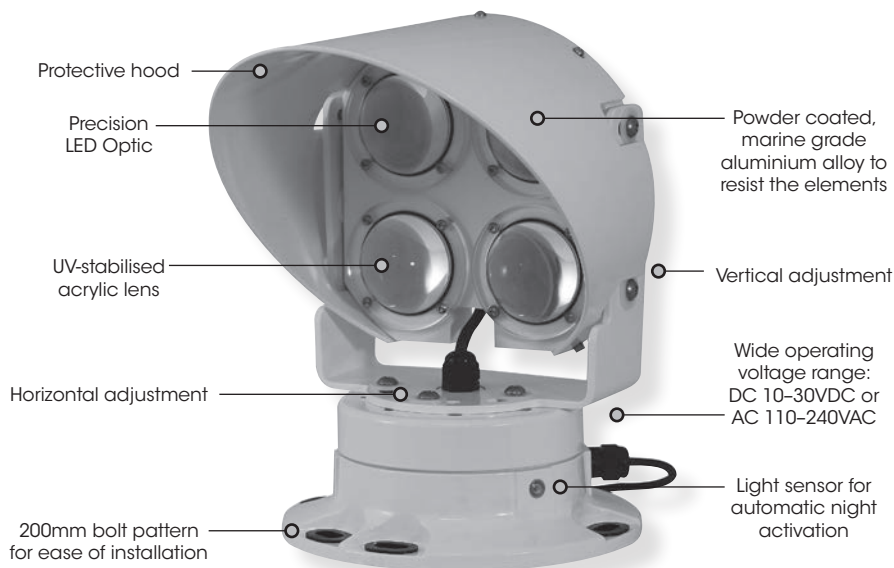

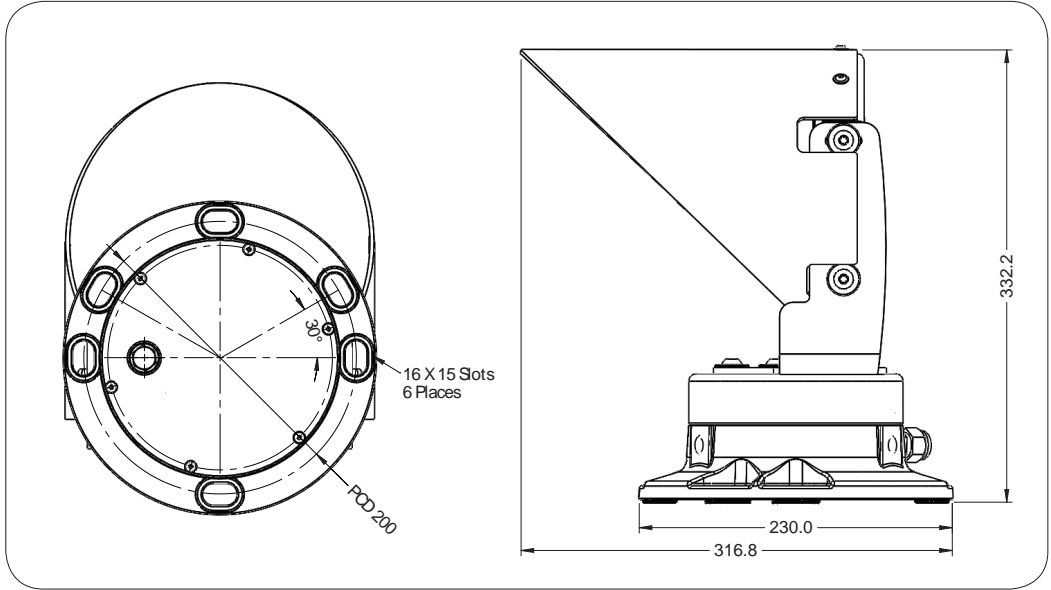

SL-RL-04

Light Characteristics

Light Source
Available Colours
Maximum Luminous Intensity (cd)†
Visible Range (NM)

Horizontal Output (degrees)
Vertical Divergence (degrees)
Available Flash Characteristics
Intensity Adjustments
LED Life Expectancy (hours)

Electrical Characteristics

Power (W)
Circuit Protection
Nominal Voltage

Physical Characteristics

Body Material
Lens Material
Lens Design
Mounting
Height (mm/inches)
Width (mm/inches)
Depth (mm/inches)
Mass (kg/lbs)
Product Life Expectancy

Environmental Standards

Shock
Vibration
Ice Loading
Wind Exposure
Hail Impact
Humidity
Temperature Range

Certifications

CE & Electrical

IALA

Quality Assurance
Waterproof

Intellectual Property

Trademarks

Warranty *

Options Available

High efficiency LEDs
White as standard. Other colours available on request
Refer to table
3deg verticle & 3deg horizontal, white:
AT @ 0.74: 23.4NM night-time, 5NM daytime
AT @ 0.85: 37.3NM night-time, 6.3NM daytime
3° as standard. Other options available
3° as standard. Other options available
Up to 310 including 256 IALA recommended, & 1 custom
User adjustable
>100,000

VDC Model: up to 28.8W VAC Model: up to 38W, 50VA
Polarity protected
VDC Model: 10-30 VDC VAC Model: 110-240 VAC

7-stage powder-coated aluminium
UV-stabilised acrylic
Multiple LED optic
3 & 4 hole 200mm bolt pattern
332 / 13
226 / 9
317 / 12½
7.5 / 16.5
Up to 12 years

MIL-STD-202G Test Condition H, Method 213B 30G vertical and 35G horizontal shock
MIL-STD-202G, Test Condition B, Method 204D 5G in all axes
Rated to withstand 22kg/m²
Rated to withstand 140knots
Rated to withstand 25mm diameter ice ball impact at 20m/s
0 - 100%, condensing
-40 to 80°C

FCC Part 15 Rules & ICES-003.
EN61000-6-1: 2007 (IEC61000-6-1:2005) Part 6-1 Immunity.
EN61000-6-3: 2007 (IEC61000-6-3: 2006) Electromagnetic compatibility (EMC) - Part 6-3 Emission.
IEC61000-4-2: 2008 Ed 2 Part 4-2 Electrostatic discharge immunity test Level 4.
IEC61000-4-3: 2010 Ed 3.2 Part 4-3. Radiated, radio-frequency, electromagnetic field immunity.
IEC61000-4-6: 2008 Ed3. , Electromagnetic compatibility (EMC) - Part 4-6 Immunity.
Signal colours compliant to IALA E-200-1
Ambient light levels compliant to IALA Guideline No. 1038
ISO9001:2008
IP68

SEALITE® is a registered trademark of Sealite Pty Ltd
3 years

- GPS Synchronisation
- AIS Type 1 or Type 3
- GSM Monitoring & Control System (External for AC, Internal for DC)
- RS232/422/485 Port
- Hard-wire Synchronisation
- Variety of solar/battery configurations
- Multiple divergence lens
- Bird deterrent spikes



• Specifications subject to change or variation without notice
* Subject to standard terms and conditions
† Intensity setting subject to solar availability

Product Components

The following components come standard with each lantern:-

- Range Light
- IR Programmer
- Installation & service manual

These components are securely packaged within foam in a carton, and shipped to you.

PLEASE NOTE: *The programming cable provided is suitable for use with PC's. If you require connection to your notebook/laptop, a Serial Port to USB cable may need to be purchased.*

Please check that ALL of these components are included with your order, and contact your Sealite representative as soon as possible if anything is missing.



Programming the Lantern

PC Configuration Tool

The lantern is pre-programmed to the customer's specific requirements for convenience (eg. flash, intensity setting etc).

The SL-RL Series are extremely intelligent lanterns with a number of features which can be programmed directly via a user-friendly computer program (as supplied on USB drive with every lantern).

To change/update the settings of your lantern, please read the following instructions.

1. Run the Programming Software

The programming software may be run directly from the USB drive provided, or you may copy the software to your computer hard-drive for future use.

Running the Programming Software from the USB Drive

- Connect the USB drive to your computer
- Navigate to the USB drive folder & double-click the file called "LanternConfig.exe". A new window will appear displaying the PC Configuration Tool.

Saving the Programming Software to Computer Hard-Drive

- Connect the USB drive to your computer
- Navigate to the USB drive folder
- Copy the file called "LanternConfig.exe" and the ".dll" files
- Navigate to the hard-drive location where you would like to save this program, and then right-mouse-click and select "paste". A copy of the programming software will now be saved to your computer hard-drive (to add the programmer to your computer desktop for ease of future access, right-mouse-click and select "Send to desktop")
- Double-click the file called "LanternConfig.exe". A new window will appear displaying the PC Configuration Tool

PLEASE NOTE: other documents have been saved on the USB drive for your information & convenience including the latest product specifications sheet and an electronic version of the installation and service manual. You may wish to view these documents to read more about the innovative features and benefits of the SL-RL Series of lanterns.

IMPORTANT: the Sealite PC Configuration Tool is designed for Windows Platforms only.

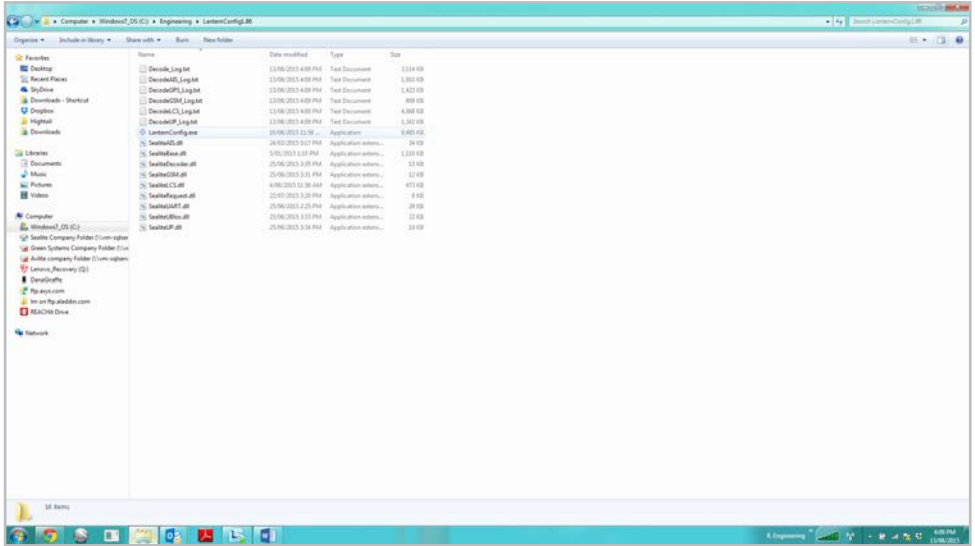

Lantern Configuration Tool Version 2.31 AUS Eastern Daylight Time: Monday, 31/Oct/2016 11:05:38AM

COM Setup Help



Info Operation Mode Flash Code Intensity Sensors Other Report

Version

Master Software Version

Master Hardware Version

Driver Software Version

Driver Hardware Version

Lantern Summary

Colour	Peak (cd)
Operation Mode	
Adv Operation Mode	
Flash Code (Dec)	
Sync Offset (Sec)	
Intensity	

Name

Set Name

Event Log Set Date

Clear Save



Image 1. Sealite PC Configuration Tool

2. Connect the SL-RL Series Lantern to a Power Source & the Computer

Now that the programming software has been run, you will need to connect the lantern to your computer & power supply so that it can receive programming commands.

Once connection is made, the software automatically determines the colour and preprogrammed settings of the lantern.

Connecting the Lantern to a Power Source

Option 1: Battery

- Connect the blue negative wire of the lantern to the battery negative terminal
- Connect the brown positive wire of the lantern to the battery positive terminal

Option 2: 12V Power Supply

- Connect the blue negative wire of the lantern to the power supply negative terminal
- Connect the brown positive wire of the lantern to the power supply positive terminal



CAUTION: to avoid personal injury do not position the lantern at eye level.

Connecting the Lantern to the Computer

- Plug the Bulgin connector end of the the programming cable into the lantern PC Programming Port, and the serial port end of the cable into your computer serial/communication port (RS232-E)

PLEASE NOTE: The programming cable provided is suitable for use with desktop PC's. If you require connection to your notebook/laptop, a Serial Port to USB cable may need to be purchased.

3. Establish the Programmer-to-Lantern Computer Connection (COM Port)

Now that the lantern is connected to the computer and the Sealite PC Configuration software has been run, the user must create the programmer-to-lantern connection.

The COM Port is the hardware port which the computer accesses when communicating with the lantern.

- Click the "COM Setup" at the top left of the PC Configuration Tool to open the "Serial Port" dialogue box
- In the "Serial Port" dialogue box select the appropriate COM Port from the drop down field for "Port Name"
- Check the "Open Port" check box to open the port
- Click the "OK" button to initiate the connection

The Sealite PC Configuration Tool will then attempt to connect/interrogate the lantern.

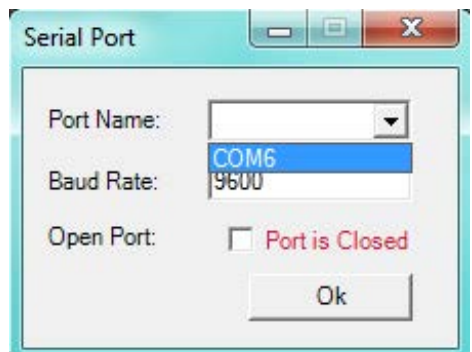

Image 2. Serial Port dialogue box

Correct Connection Established

If the connection is established data about the lantern configuration will appear on the “Info” tab under the headings “Version” & “Lantern Summary” (eg. Lantern Colour, Flash Code, Intensity etc).

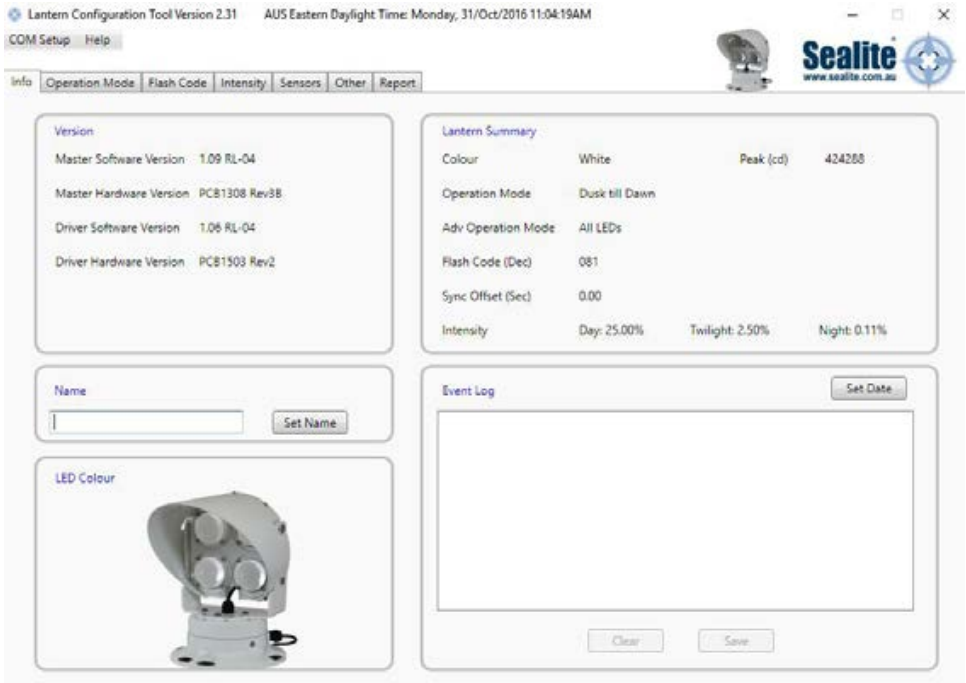

Image 3. Sealite Configuration Tool “Info” tab – showing COM Port connection established, Version & Lantern Summary information

Connection NOT Established

If the connection is not available, the Sealite PC Configuration Tool will not display any lantern specific information under the headings “Version” & “Lantern Summary”. If this error occurs, please check the following:

- Reconnect the lantern to the computer
- Check that the lantern power supply has sufficient charge (eg. battery is charged), and then reconnect it to the lantern
- Re-run the Sealite PC Configuration Tool and follow the information in step 3. The connection should now become established.

The Sealite lantern is now ready to be programmed to your specific requirements.

Info Tab

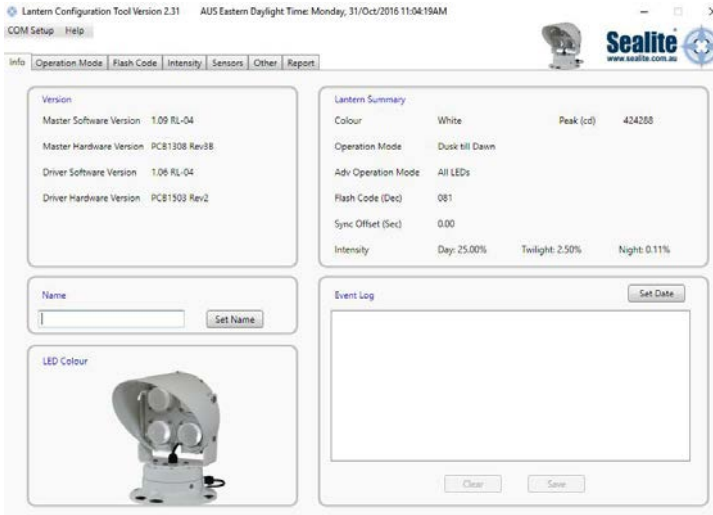

The screenshot shows the 'Info Tab' of the Lantern Configuration Tool. At the top, it displays 'Lantern Configuration Tool Version 2.31' and 'AUS Eastern Daylight Time: Monday, 31/Oct/2016 11:04:19AM'. Below this are navigation tabs: 'COM Setup', 'Help', 'Info', 'Operation Mode', 'Flash Code', 'Intensity', 'Sensors', 'Other', and 'Report'. The 'Info' tab is active, showing several panels:

- Version:**
 - Master Software Version: 1.09 RL-04
 - Master Hardware Version: PCB1308 Rev3B
 - Driver Software Version: 1.06 RL-04
 - Driver Hardware Version: PCB1503 Rev2
- Lantern Summary:**
 - Colour: White, Peak (cd): 424268
 - Operation Mode: Dusk till Dawn
 - Adv Operation Mode: All LEDs
 - Flash Code (Dec): 081
 - Sync Offset (Sec): 0.00
 - Intensity: Day: 25.00%, Twilight: 2.50%, Night: 0.11%
- Name:** A text input field with a 'Set Name' button.
- LED Colour:** A panel containing a photograph of the lantern and a 'Set Date' button.
- Event Log:** A large empty text area with 'Clear' and 'Save' buttons at the bottom.

Provides a summary of the lantern configuration settings, hardware and software versions, and event log.

Version

Is an information panel that identifies the Lantern's internal electronic hardware and firmware versions.

Lantern Summary

Is an information panel that displays a summary of the key lantern settings: colour, operation mode, Peak Intensity setting, Advance Operational Mode, Flash Code, Flash Sync offset and Intensity setting. Refer to the Information, Operation Mode Flash Code, and Intensity Tabs for a description of these parameters.

Name

A user defined name, comprising alphanumeric characters (and -, \$, #, @) can be typed into dialogue box and by pressing and stored within the lantern's non-volatile memory by pressing the 'Write Name' button.

LED Colour

A generic picture of the lantern model and colour that the software tool is communicating with is displayed in this panel.

Event Log

Displays the alarm events recorded by the lantern firmware. Possible alarms (flat battery, low battery, LED failure, high temperature). All alarm events are recorded irrespective of whether the lantern has been configured to respond to an alarm.

- To set the date, click 'Set Date', choose date and time, press 'Send'
- To clear the event log, click 'Clear' and select 'Yes'

Operation mode Tab

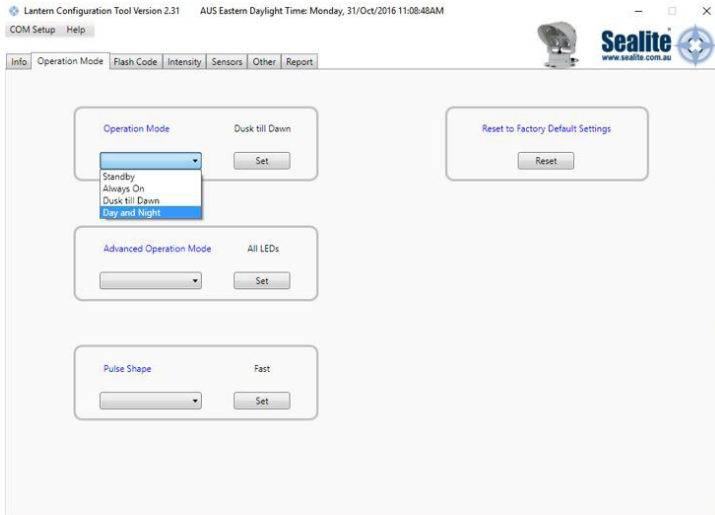

Pulse Shape

The pulse shape of each flash can be altered to produce a softer light , whereby the intensity will ramp up and down at the beginning and end of each flash.

Defines the lanterns mode of operation of which there are four possibilities:

Operational Mode

Standby

The lantern is configured in a minimum current state in which the LEDs are always off and the internal GPS (if installed) is disabled.

Always On

The daylight sensor is disabled and the lantern operates according to the set flash character and intensity levels.

Dusk till Dawn

The daylight sensor is monitored and the lantern will only operate at night time.

Day and Night

The daylight sensor is monitored and the lantern will operate according to the set flash character and



intensity levels for Day, Twilight and Night.

Adv Op Mode

This is an advanced user mode and typically only used if the lantern is to be used as a special navigational aid such as emergency wreck mark.

All

Default on setting. All LEDs are operated in unison and configured by the Operation Mode, Flash Code and Intensity Tabs.

Reset

By clicking Reset, the factory set default parameters are restored.

Flash Code

Lantern Configuration Tool Version 2.31 AUS Eastern Daylight Time: Monday, 31/Oct/2016 11:11:30AM

COM Setup Help

Info Operation Mode **Flash Code** Intensity Sensors Other Report

Mariner Characteristic Selection

Mariner Code: FL

Flash Code Name: 1

Flash Code (Dec): Timing: 1 Flash followed by number e.g. FL 1 S, one flash every seconds

Current Code: FL 55

Sealite Code Selection

IR Flash Code Switch Flash Code

Current Code (Dec): 081 Set

Sync Offset (Sec) (Max=5.15Sec)

(Note: GPS antenna must be connected to utilise this feature.)

Current Sync Offset: 0.00 Set

Manual Entry Custom Flash Code (999) Timings

On (Sec)	Off (Sec)	On (Sec)	Off (Sec)

Set

(Note: Choose FFF or 999 to enable a special flash code.)

Marine Characteristic Selection

The flash character is defined by first selecting the Mariner code, then the Flash code name and finally timing.

Sealite Code Selection

This is an alternative method to select the lantern flash code by using either the Sealite IR remote control numerical figure or if known the Sealite rotary switch flash character. Refer to the IR remote control section for valid flash characters.

Sync Offset

This panel is used to set a fixed delay to the commencement of the flash character. The built-in GPS receiver and advanced software of the Sealite synchronised lanterns allow for the adoption of SeaFlare™ channel marking – a unique system that cascades the flash synchronisation of channel lanterns in a uni- or bi-directional flash pattern. By default this figure is set to zero.

Manual Entry Custom Flash Character

In this panel one, custom flash characteristics can be defined with up to 10 individual on/off times.

Intensity

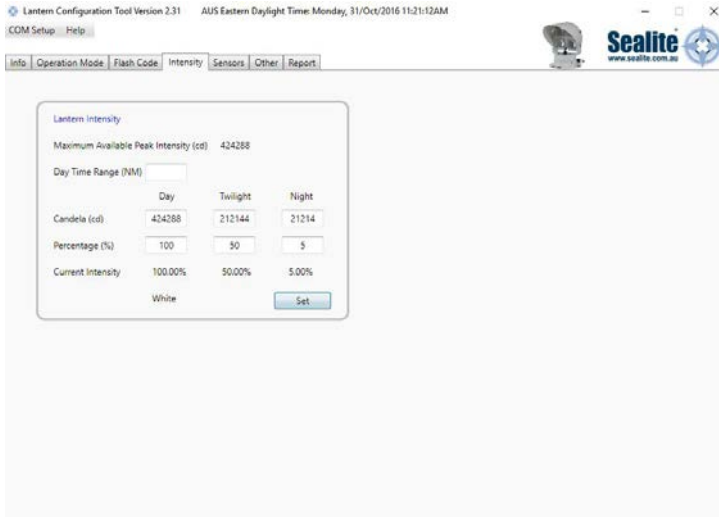

Lantern Intensity

The lantern intensity level can be set by either defining the operating range on the lantern (in nautical miles) or by entering a desired peak candela or by entering a percentage of maximum peak intensity level. It can be set in steps of 0.1%, eg 53.7%

If an intensity level is selected that is beyond the specification of the lantern, the entered figure will be displayed in red coloured text, and the lantern will be configured to its maximum.

Sensors

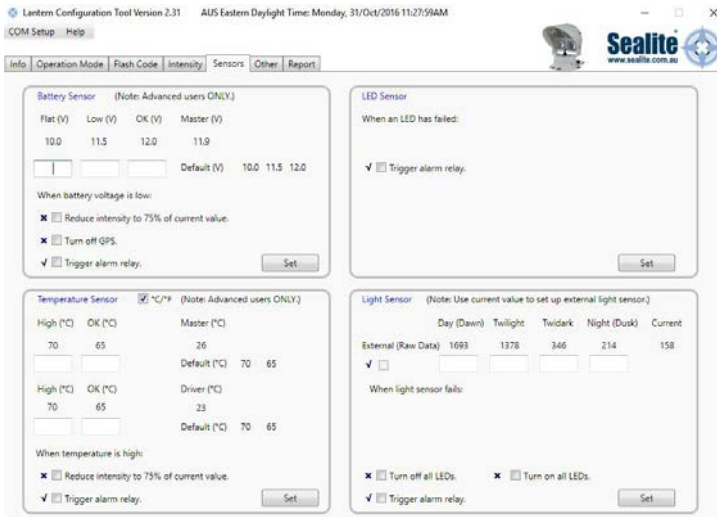

Lantern Configuration Tool Version 2.31 AUS Eastern Daylight Time: Monday, 31/Oct/2016 11:27:59AM

COM Setup Help

Info | Operation Mode | Flash Code | Intensity | **Sensors** | Other | Reports

Battery Sensor (Note: Advanced users ONLY)

Flat (V)	Low (V)	OK (V)	Master (V)
10.0	11.5	12.0	11.9

When battery voltage is low:

- Reduce intensity to 75% of current value.
- Turn off GPS.
- Trigger alarm relay.

Set

LED Sensor

When an LED has failed:

- Trigger alarm relay.

Set

Temperature Sensor °C/°F (Note: Advanced users ONLY)

High (°C)	OK (°C)	Master (°C)
70	65	26
		Default (°C) 70 65
High (°C)	OK (°C)	Driver (°C)
70	65	23
		Default (°C) 70 65

When temperature is high:

- Reduce intensity to 75% of current value.
- Trigger alarm relay.

Set

Light Sensor (Note: Use current value to set up external light sensor.)

Day (Dawn)	Twilight	Twilight	Night (Dusk)	Current
External (Raw Data) 1693	1378	346	214	158

When light sensor fails:

- Turn off all LEDs.
- Turn on all LEDs.
- Trigger alarm relay.

Set

Battery sensors

The SL-RL series of lantern continuously monitors its input voltage using three definable thresholds.

- For voltages greater than “OK” level, the lantern reports via IR Remote control requests or the GSM that the input voltage is satisfactory.
- For voltages below “low” the lantern can be configured to operate the internal alarm relay and /or reduce the intensity level by 25% as a measure to extend the operation of the lantern until it reaches the “Fail” voltage.
- At “Fail” the lantern shuts down entirely, and turns of the GPS and the mains LEDs. The lantern will only commence operation once the input voltage has exceeds the “OK” voltage level.

The three thresholds: Flat, Low and OK are user definable.

Temperature

The SL-RL utilises two temperature sensors. One that monitors the temperature of the master board, and one that monitors the temperature of the driver board.

Each sensor has two configurable temperature thresholds: “High” and “OK”. There are also two configurable options for when the “High” temperature threshold is exceeded.

- “Reduce intensity to 75% of current value”.
- “Trigger alarm relay”.

When the “High” temperature threshold is exceeded for either board, any of the selected options will be acted upon.

The enabled options will remain active until the board temperatures both reduce to below the “OK” threshold.



LED Sensor

Built into the SL-RL lantern, is a closed loop monitoring system for each LED within the lantern. In the event of a single LED failure, the lantern can be configured to trigger the internal alarm relay which in turn can be connected externally to trigger other devices, such as redundant light source.

Light Sensor

The SL-RL lantern has its own external light sensor and whose day/twilight/twidark/night thresholds are defined in LUX. These levels can be customised by entering in separate values as a measure of LUX.

NOTE:

Twilight: this refers to the time between Day and Night

Twidark: this refers to the time between Night and Day

Due to the placement of some Aids to Navigation in regards to the position of the sun, some ports may find it advantageous to adjust these settings accordingly.

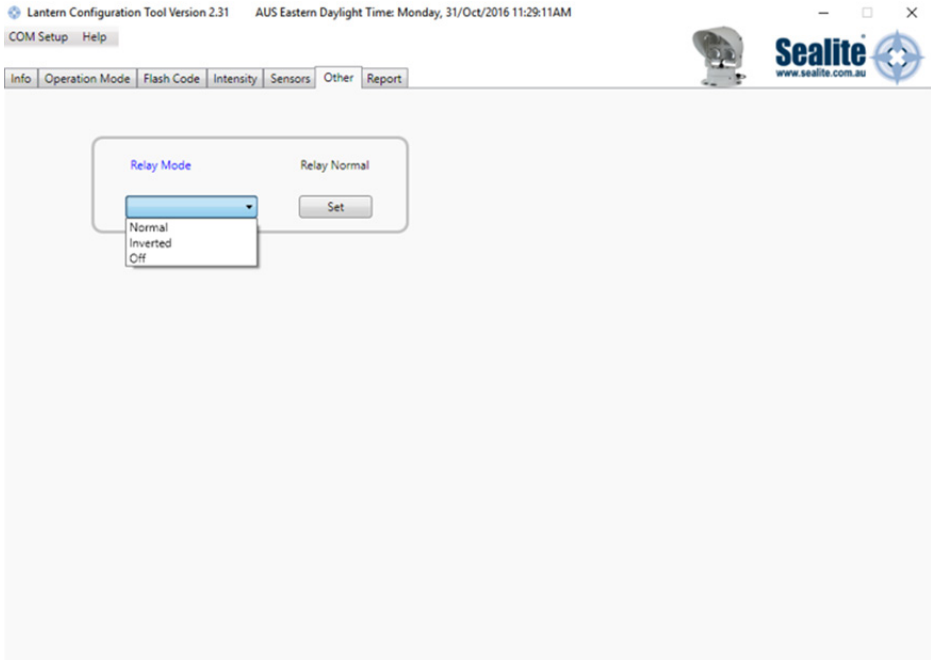

Relay Mode

The lantern contains an internal relay. This can be configured to send a signal to a third party alarm. The relay can be configured to be in one of three states Normal, Inverted and Off.

Normal Mode

The relay is energised during operation. The relay draws 16mA when in operation

Inverted Mode

The relay is only energised when an alarm event is triggered by the lantern.

Off Mode

The relay is disabled.

AIS Report

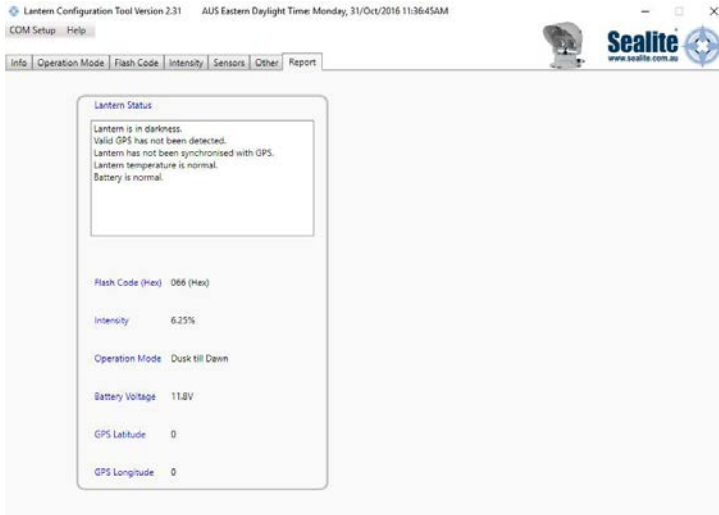

Lantern Status

This panel displays the lantern's AIS message that is output via the serial communications port every 10 seconds. Typically this message is processed by an externally installed AIS module, however by itself is a quick summary of the lantern's operating status. This detail is also displayed on the INFO tab.

IR Programmer

The IR programmer is used to communicate with Sealite lighting products that have an IR sensor fitted. The remote control is used for the following functions:

- Flash Code: read the current flash code, configure a new flash code.
- Lamp Intensity: read the current lamp intensity, configure a new intensity level.
- Ambient Light Thresholds: read the current light thresholds, configure new ambient light thresholds.
- Perform a battery health check.

On receiving a valid key signal from the IR Programmer, the light will flash once. The user should wait until the light responds to each keypress before pressing another key. If there is no response to the keypress after 3 seconds, it has not been detected by the light and the key can be pressed again.

If an invalid key is detected, the light will flash quickly 5 times. In this case, the command will have to be restarted.

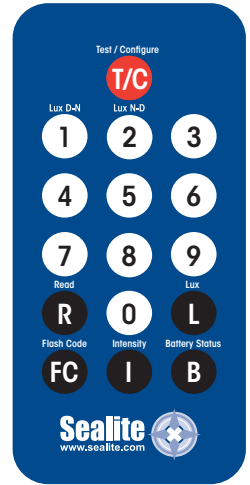

Sealite IR Programmer / Universal Remote Compatibility

If you lose your Sealite IR Programmer, the following Universal Remote Controller has been tested for compatibility: RCA Type RCR312WR programmed for Phillips TV Type Code 10054

Sealite Key	Universal Remote Key
T	Power
1	1
2	2
3	3
4	4
5	5
6	6
7	7
8	8
9	9
0	0
R	Channel+
L	Mute
FC	Volume+
I	Volume-
B	Channel-

IR Programmer Functions

Test Mode / Configure



Pressing the T/C button for up to 5 seconds places the light in Test Mode. The light will flash once in response to the T/C button being pressed and then turn off.

Normal Operation





















The light will return to normal operation once it has not detected a valid key press for 30 seconds. The light will flash once to indicate it is returning to normal operation.

Read

Pressing the Read followed by one of the configuration keys shall cause the light to flash the configured value.

For example if the current Flash Code is set to 51 via the AB switches, the lamp will flash number 081. For a flash code set to 01, the lamp will flash 001.

Example Key Sequences:

- 

 The light flashes the 'IR Remote' number belonging to the currently set Flash Code. Refer to the Flash Code tables to match the 'IR Remote' flash number to the Flash Code.
- 

 The light flashes the current intensity setting: 1 flash for 25%, 2 for 50%, 3 for 75% and 4 for 100%.
- 

 The light flashes the current battery status.
- 

 The light flashes the sunset level in Lux, followed by a 2 second gap, followed by the sunrise level. Levels are in the range of 1 to 5.
- 



 The lantern flashes the current GPS Mode.
- 



 The lantern flashes the current Operational Mode.



Flash Code

FC

This key sets the flash code on the light.

Example Key sequence:



This sets the flash code to value 123. The light responds by flashing one long flash to indicate the command was successful.

Flash Code Numbers

The lamp flashes numbers as follows: Hundreds, Tens, Ones. A value of 125 will be flashed as: 1 flash, followed by a delay, 2 flashes, followed by a delay, 5 flashes.

The flash for number 0 is one long flash.

Intensity

This function sets the light intensity based on the lantern's daytime operational range of the lantern.

The twilight and night time intensities are then calculated and applied by the lantern.

Valid intensity values are 1 for 25%, 2 for 50%, 3 for 75% and 4 for 100%.

Example Key sequence:

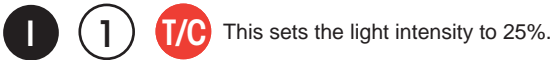

The intensities are based on the intensity values that have been programmed in the lantern. The maximum allowable range is dependent on the lantern's vertical divergence, LED colour and flash character.

Using the selected operational range and current flash character, the lantern uses the Schmidt-Clausen Method, as described in IALA E200-4 to determine the peak intensity.

If the flash character is changed, the peak intensity is automatically adjusted.

Note: To set different intensities for Day, Twilight and Night time please use the PC Configuration Tool.

Battery Status

B

This function reads the battery status. The response from the light is High Voltage: 4 flashes, Good Voltage: 3 flashes, Low Voltage 2 flashes, Cutoff Voltage or below: 1 flash.

Example Key sequence:

R

B

T/C



Error / Acknowledge Indication

If the key sequence is invalid, or an out of bounds value is entered, the light flashes 5 times quickly.
(The command then needs to be re-entered from the start.)

Example key sequence: (Set the intensity level to 5 – undefined.)



The lantern flashes five times quickly.

When a key sequence has been entered successfully the light will respond acknowledgement with a long flash.

Configuration Settings

The intensity and flash codes can be changed using the switches on the lantern circuit board or with the IR Remote Control. The lantern intensity and flash code settings are set to the last detected change, carried out with the IR Remote Control or by changing the switch positions.

Example #1: If the intensity is set at 100% with the intensity switches, and is then set to 50% using the IR Remote Control, the intensity setting will change to 50%. If the intensity is then set to 75% using the switches, the new intensity value will be 75%.

In order to change intensity settings using the IR Remoter Control, the lantern must be powered.

The lantern can detect a change in switch settings if they are changed while the lantern is powered down.

Example #2: The flash code is set according to the switch settings: A=5, B = 1. The operator changes the flash code to 65 (A=4, B=1) using the IR Remote Control. The new flash code is now configured to A=4, B=1. The lantern is powered down and the operator changes the flash code switches to A=3, B=1 and powers on the lantern. The new flash code is now A=3, B=1. If the flash code is read from the lantern using the IR Remote Control, the lantern will flash 49 which is the corresponding number for switches A=3, B=1.

Use the IR Remote Control to read the current lantern intensity setting and flash code.

Operational Mode (Advanced users)

The lantern has four modes of operation: *Always on, Day & Night, Standby Mode and Dusk-to-Dawn* mode. These modes can be selected either via the IR remote control or via the GSM module (if fitted).

In Always On mode, the daylight sensor is disabled and the lantern will remain ON.

In Standby mode, the lantern is turned off and the daylight sensor is disabled. This mode does not affect the operation of the GSM module.

In Dusk-to-Dawn, the daylight sensor is enabled.

B **I** **1** **T/C** Always on mode

B **I** **2** **T/C** Standby mode

B **I** **3** **T/C** Dusk-to-Dawn mode

B **I** **6** **T/C** Day and Night

GPS Mode (Advanced Users)

The Lantern has four modes of GPS operation. Off, Normal, Fast and On. These modes can be selected either the IR remote control or via the GSM Module (if fitted)

In Off mode the GPS module is disabled, the Lantern will not sync with other lights if the GPS is turned off.

In Normal mode the GPS is turned off for 15 minutes at night and 30 minutes during the day.

In Fast Mode the GPS is turned off for 5 minutes at night and 15 minutes during the day.
In On mode the GPS is always on.

L **F/C** **0** **T/C** GPS Mode Off

L **F/C** **1** **T/C** GPS Mode Normal

L **F/C** **2** **T/C** GPS Mode Fast

L **F/C** **3** **T/C** GPS Mode On

Power Basics

- (a) Power is a measure of the rate in which electrical energy is transferred within an electrical circuit and is measured in Watts (W). For DC (Direct Current) electrical circuits it is expressed as:

$$\text{Power (Watts)} = \text{Voltage (Volts, V)} \times \text{Current (Amps, A)}$$
 where volts & current are instantaneous values.
- (b) Peak Power is the maximum power rating of a Lantern. In an instant of time, this is the maximum power the lantern will consume. It is determined when all a lantern's features are on and the LEDs intensity is at 100%.
- (c) Average Power is a measure of Power over a period of time. In raw terms, it expressed as

$$\text{Average Power (Watts)} = \text{Peak power (Watts)} \times \text{MULTIPLIER (\%)}$$
 where the MULTIPLIER (%) = Flash Character duty cycle (%) x Intensity level (%)
- (d) The SL-RL-04 lanterns intensity setting are available in 1000 steps from 0% to 100% with a step size of 0.1% (or 1/1000%)

SL-RL-04

		Red	Green	White
Peak Current		1.69A	1.98A	2.25A
Peak Power @ 12V		20.05W	23.8W	27.0W
Peak intensity (cd)	3 Degrees	144400	138060	413800
	8 Degrees			
Voltage range (VDC)		12 to 24	12 to 24	12 to 24

Electrical Consumption of Control and Flasher

SL-RL-04 Series at 12V

Parameter	(mA)	(W)	Description
Iq, Quiescent current			Consumption during the day and night time
Ie, Eclipse Current			Consumption between flashes
Igps (average)			Consumption over the entire day
Irelay	15		Consumption when energized (Normal Mode)



Lantern Testing

Now that the SL-RL has been programmed to suit the project requirements, it's important that the lantern is tested prior to installation, including flash code and intensity settings.

To test the SL-RL:

- Connect the SL-RL to a 12V power supply or battery
- For lanterns programmed to "Dusk to Dawn" operation setting, cover lantern with a dark cloth or jack in darkness for more than 1 minute. After this time the lantern will activate
- Next, check that the lantern is flashing to the required flash code and intensity
- If the settings are correct, disconnect from the 12V power supply or battery
- If the settings are incorrect, following the Programming Instructions of this manual to re-configure lantern characteristics, and then re-test prior to installation

IMPORTANT: when lantern is being programmed using the Sealite PC Configuration Tool software, it is recommended that the operation setting is set to "Always On" for ease of testing/viewing new settings. Once the programming is complete, remember to change the operation mode back to your specific installation requirement (Sealite recommend "Dusk to Dawn" mode).

Lantern Installation

The Sealite SL-RL may be installed with connection to mains power, or as a complete solar powered system (available from Sealite).

IMPORTANT: the SL-RL must be installed appropriately where the lantern is not blocked by buildings, trees or other shadows that may affect the visibility of the lantern or the ambient light.

Option 1: Installation of Lantern to Mains Power

To connect the SL-RL to a 12VDC power supply:

- Connect the blue negative wire of the lantern to the power supply negative terminal
- Connect the brown positive wire of the lantern to the power supply positive terminal

IMPORTANT: it is important that a minimum 5Amp AC-DC power supply is connected between the mains power and the lantern to maximise the life of your product.

Option 2: Installation of Lantern to Solar Powered System

Sealite has an optional complete solar powered system available to purchase with the standard SL-RL lantern. Detailed instructions for installation of the solar system are listed as follows.

1. Unpacking Instructions

Unpack all hardware and verify container contents in accordance with Figure 2. Please contact your Sealite representative if there is any hardware missing.

2. Initial Inspection

Inspect all hardware for damage. If there is any damage, please contact your Sealite representative.

3. Installation

Refer to Figure 1 "Panel & Cage Footprint" and Figure 2 "Installation of Solar Panel & Battery Box Cage" during installation of the panel and cage.

3.1 Installing the Post

A suitable mounting point for the Solar Panel and Battery Box Cage is to be provided by the client. It is usual to use a purpose installed post.

The following should be observed:-

- The post should be of a durable timber, or other durable material.
- Recommended minimum post size is 150mm x 150mm, or larger if the battery box cage needs to be installed immediately beneath the solar panel.
- The length of post required is the sum of exposed length (normally 1.25m) plus the required depth into the ground which is dependent on local soil conditions (recommended depth 850 minimum).
- The faces of the post must be aligned with the cardinal points of the compass. This will allow the Solar panel to be aligned with the equator and sun.
- The post should not be more than 20m from the lantern, and should not be located so as to place the solar panel in shade for a significant time.
- The solar panel is tempered glass, so the post should be located away from any objects which might fall on the installation.
- The post and equipment footprint should be at least 300mm clear of any shading under all conditions.

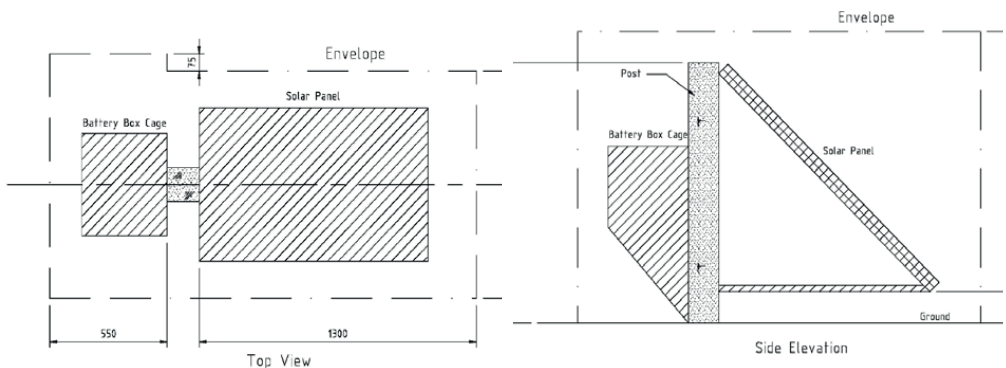

Ref No.	Description	No. Required
2.1	140W Solar Panel & Frame	1
2.2	Battery Box Cage	1
2.3	Post, 150x150 minimum	Client Supplied
2.4	Steel Support	1
2.5	Steel Brace	1
2.6	Screw, 12mm x 75	12
2.7	Washer, 12mm	12
2.8	Bolt, 10mm x 25	4
2.9	Washer, 10mm	4
2.10	Self Locking Nut, 10mm	4

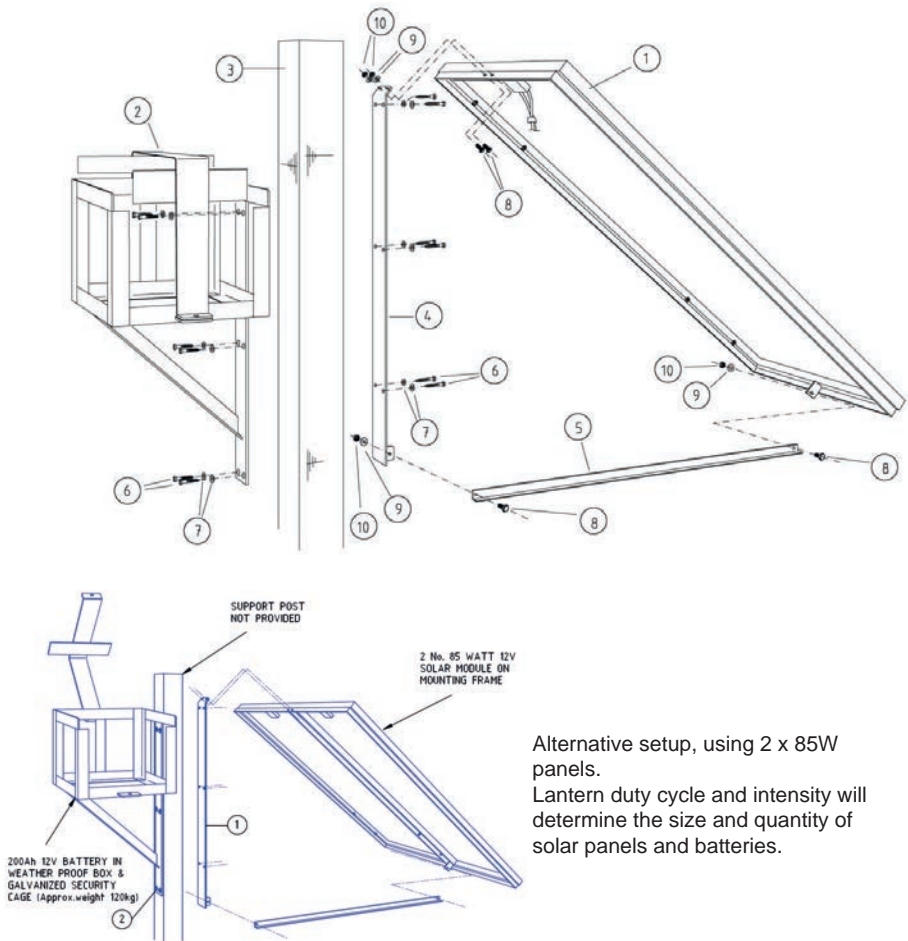

Alternative setup, using 2 x 85W panels.
Lantern duty cycle and intensity will determine the size and quantity of solar panels and batteries.

Figure 2. Installation of Solar Panel & Battery Box Cage



3.2 Installing the Solar Panel & Battery Box Cage

The battery box cage (Ref 2.2) and the steel support bracket (Ref 2.4) are attached to the post (Ref 2.3) using coach screws and washers (Ref 2.6, 2.7).

- a. Drill the post for the steel support bracket (6 places) and install using supplied screws

IMPORTANT: *the Solar Panel must face the equator. Locate the solar panel support bracket accordingly.*

- b. Drill the post for the battery box cage (6 places) on the opposite side to the solar panel and install using supplied screws.
- c. Install the solar panel and frame (Ref 2.1) and the brace (Ref 2.5) to the steel support bracket using bolts (Ref 2.8), washers (Ref 2.9) and nuts (Ref 2.10).

3.3 Installing the Battery Box

Refer to Figure 3 “Battery and Battery Box” during installation of the battery and battery box.

- a. Open the battery box cage door and place the battery case (Ref 3.1) into the cage with the hinge of the case adjacent to the hinge of the cage.
 - b. Open the battery case and lower the battery into the case ensuring the battery terminals are upright.
 - c. Insert one bolt (Ref 3.3) with a washer (Ref 3.4) under the head through each of the battery terminals.
 - d. Place the red eye connector over the tail of the bolt protruding through the red battery terminal.
 - e. Fit a washer (Ref 3.4), spring washer (Ref 3.5) and nut (Ref 3.6) on the terminal bolt. Tighten.
 - f. Place the blue eye connector over the tail of the bolt protruding through the black battery terminal. Fit a washer (Ref 3.4), spring washer (Ref 3.5) and nut (Ref 3.6) on the terminal bolt. Tighten.
 - g. Insert the end of the cable from the solar panel through one of the cable glands in the back of the battery case. Join bullet connectors, red to red and blue to blue.
-
- Test the lantern. Cover the lantern completely to resemble night time. Allow 60 seconds for the lantern to activate.
 - Uncover the lantern and it will turn off after 60 seconds.

Ref No.	Description	No. Required
3.1	Battery Case, SPC353534	1
3.2	Battery, 12V 70AH or equivalent	1
3.3	Bolt, battery	2
3.4	Washer, battery	4
3.5	Spring Washer, battery	2
3.6	Nut, battery	2

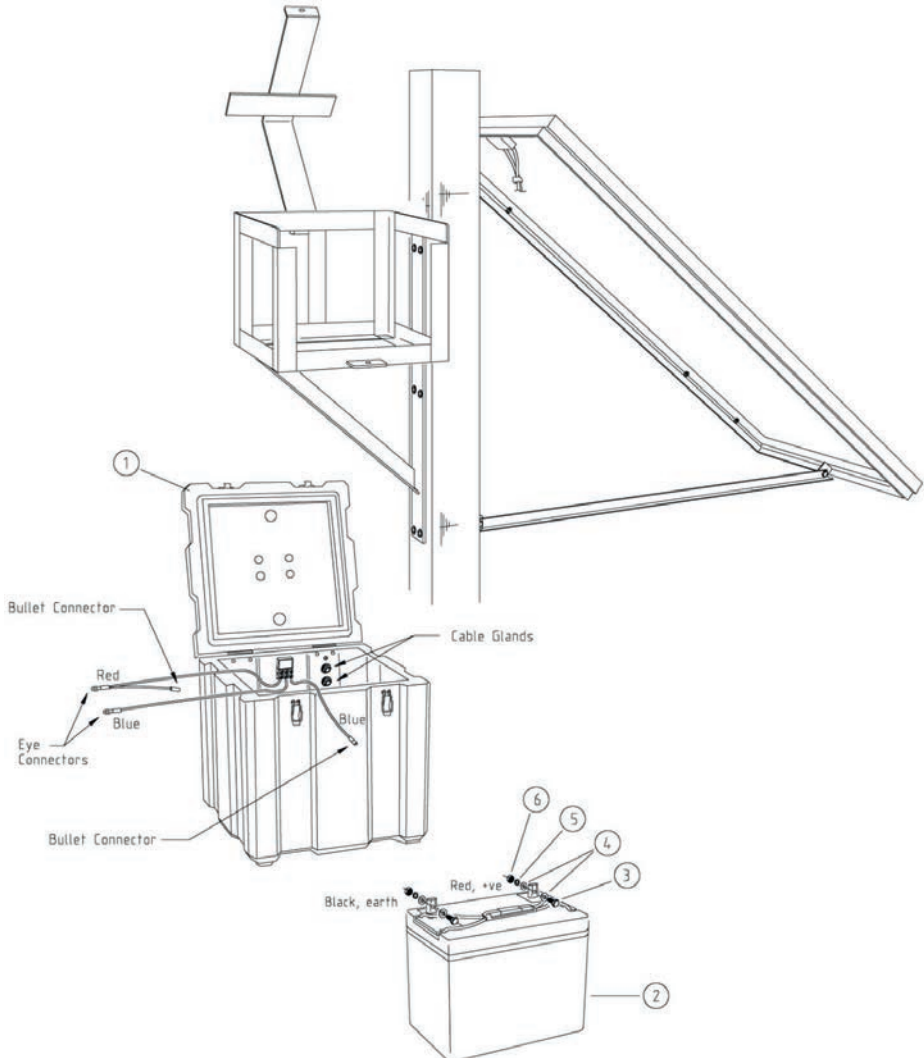

Figure 3. Battery and Battery Box



3.4 Connecting the Lantern

To connect the SL-RL to the solar powered system:

- Connect the blue negative wire of the lantern to the battery negative terminal.
- Connect the brown positive wire of the lantern to the battery positive terminal.

The lantern must to be connected to a 12VDC power supply.

Please ensure the solar panel array has been installed appropriately. To maximise solar collection, the solar panel array should be installed facing the equator and in a location that ensures it will not be shaded by buildings, trees or other structures. **Solar panels will significantly reduce in efficiency if a small shadow is positioned over the solar panel.**

***IMPORTANT:** it is important to work with the team at Sealite when determining the quantity and size of both batteries and solar panels for this lantern. Duty cycle, intensity and local solar conditions are important factors to take into consideration when building a solar powered battery supply.*

Sealite solar marine lanterns will give years of trouble free service if installed correctly initially.

- Please ensure all connections are tight
- Please ensure that solar panels are always clean and free from bird droppings and shade and that the solar array is pointed toward the sun to maximise solar collection
- Please ensure that battery box covers are latched properly and that cages are secured appropriately, to prevent theft and vandalism

Please contact your Sealite representative if you have any questions regarding the installation and service of the lantern.



Optional GPS Synchronisation

The lanterns can be fitted with a GPS module, and provide the user with the ability to install independently operating lanterns that all flash in synchronisation.

No additional power supplies, aerials or control systems are required, and with its microprocessor- based system, the GPS option is specifically designed to provide maximum reliability and performance over a wide range of environmental conditions.

Operating Principle

Each light operates independently and requires no operator intervention. A minimum of 4 satellites need to be in view for the built-in GPS receiver to collect time data. At dusk, the light sensor will turn the light on. If time data is available the light will come on synchronised to every other light with the same selected flash code.

Synchronisation is achieved using an internal algorithm based on the highly accurate time base and time data received from the satellites. The satellite data is provided from a number of earth stations using atomic clocks as the time base. Continuous self-checking ensures that the light will continue to run in synchronisation.

Operation Mode

The Lantern has four modes of GPS operation. Off, Normal, Fast and On. These modes can be selected either the IR remote control or via the GSM Module (if fitted). Please see Pg. 27 for an detailed example. In Normal mode the GPS is turned off for 15 minutes at night and 30 minutes during the day. In Fast Mode the GPS is turned off for 5 minutes at night and 15 minutes during the day. In On mode the GPS is always on. In Off Mode the GPS is always disabled.

Light Activation

At power-up the microprocessor checks that the internal GPS module is programmed correctly and is able to provide valid time base and time data.

Once outside with a clear view of the sky, valid data should become available within 20 minutes.

Daylight Operation

During daylight hours the microprocessor is in idle mode to reduce power consumption. Time data continues to be updated once per second. The microprocessor will automatically exit the idle mode as soon as dark conditions are detected.

Dark Operation

When dark conditions are detected the light:

- Checks for valid time data and is turned on after a delay based on the current time and the length of the selected flash code;
- If valid time data is not detected the light will turn on after approximately 10 seconds. This light will not be synchronised.
- If the light turns on unsynchronised it will continually check for valid time data. Once valid data is found the light will automatically synchronise.

Note: Lights will not synchronise if different flash codes are selected.

Optional GSM Monitoring & Control System

The lanterns may also be fitted with GSM Cell-Phone Monitoring and Control – enabling users to access real-time diagnostics data and change lantern settings via cell-phone. The system can also be configured to send out alarm SMS text messages to designated cellular telephone numbers. users can also have alarms and reports sent to designated email addresses.

Please contact Sealite for further information and instructions.



Maintenance & Servicing

Designed to be virtually maintenance-free, the SL-RL Series will require minimal attention.

However, the following maintenance and servicing information is provided to help ensure the life of your Sealite product.

1. Cleaning Lens - occasional cleaning of the lantern lens may be required. Using a cloth and warm soapy water, wipe off any foreign matter before rinsing the lens with fresh water.
2. Ensure the external vent and programming port are free from foreign material.

Trouble Shooting

Problem	Remedy
Unable to communicate with lantern via USB	<ol style="list-style-type: none"> 1. Connect the USB drive provided by Sealite to the PC and open to view files. 2. Double-click on the file: Configx.xx.exe (note, version number may vary). 3. Extract the executable file. 4. Connect the lantern to a power source. 5. Connect the lantern to the PC. 6. Click "COM Setup". 7. Select the appropriate COM Port from the drop down menu in the "Serial Port" dialogue box. 8. Ensure the "Open Port" check box is selected and "Port is Open" is displayed. 9. Click "OK". 10. Lantern should be connected and ready for programming.
Lantern will not activate.	<ul style="list-style-type: none"> • Ensure lantern is in darkness. • Wait at least 60 seconds for the program to initialise in darkness. • Ensure battery terminals are properly connected. • Ensure lantern is connected to a 12volt power supply.
Programming settings will not change	<ul style="list-style-type: none"> • Check programming cable is properly connected to both lantern and computer, and check that the lantern is connected correctly to a power source (and that the power source is charged eg. battery).

There are two status LED's located on the master circuit board.

The red status LED is used to indicate the health of the lantern's power system, eg battery voltage. The Yellow status LED is used to indicate the operational status of the lantern. Eg. GPS synchronisation. These indicator LEDs can be viewed through the side of the base of the lantern.

Yellow LED	Lantern Status	Lantern	Comment
OFF	Normal	OFF	Lantern is in Daylight and in Dusk till Dawn mode or in Standby Mode
Flashing ON 0.15 seconds OFF 0.15 seconds	Normal	OFF	Light is activating and will turn on after detecting 30 seconds of continuous darkness.
Flashing 2 x quick flashes every 2 seconds (Heartbeat)	Normal	ON	Lantern is in Normal operating condition. It is not connected to any GPS synchronisation.
Flashing ON 1.5 seconds OFF 1.5 seconds	Normal	ON	Normal operating condition. Lantern is synchronised to GPS-enabled lanterns.
Flashing 1 x quick flash every 2 seconds	Normal	ON	Lantern is 're-syncing' with GPS. The lantern re-sync's with the GPS every 15 minutes.
Flashing 2 x quick flashes every 11 seconds	Normal	ON	Lantern is a Hard Wire Synchronisation Slave.

Red LED	Lantern Status	Lantern	Comment
OFF	Normal		Normal Battery Voltage
Flashing once every 1.6 seconds	Battery Voltage is 12 – 12.5V		Battery Voltage is between 12 – 12.5V
Flashing twice every 2 seconds	Battery Voltage is 11.5 – 12V		Battery Voltage is between 11.5 – 12V
Flashing 3 x times every 2 seconds	Battery Voltage is 10.5 – 11.5V		Battery Voltage is between 10.5 – 11.5V
Flashing 4 x times every 2.5 seconds	Battery Voltage is 10.0 – 10.5V		Battery Voltage is between 10.0 – 10.5V
Flashing 5 x times every 3 seconds	Battery Voltage is less than 10.0V		Battery Voltage is at less than 10.0V
Fixed-on	Flat Battery (<10V)	OFF	Flat Battery cut-off is now operational and the lantern will be off. Battery must receive charge (above 12V) and lantern must see daylight for at least 1 minute before resuming normal operation.
Flashing ON 1.5 seconds OFF 1.5 seconds	Battery Voltage is above 13.5V		Battery Voltage is above 13.5V. this may indicate a problem with the solar regulator.

SWITCH		IR Controller	FLASH CODE	ON	OFF
A	B				
0	0	000	F (Steady light)		
D	3	211	VQ 0.5 S	0.2	0.3
E	3	227	VQ 0.6 S	0.2	0.4
F	3	243	VQ 0.6 S	0.3	0.3
7	3	115	Q 1 S	0.2	0.8
8	3	131	Q 1 S	0.3	0.7
9	3	147	Q 1 S	0.4	0.6
A	3	163	Q 1 S	0.5	0.5
8	4	132	Q 1 S	0.8	0.2
B	3	179	Q 1.2 S	0.3	0.9
9	4	148	Q 1.2 S	0.5	0.7
C	3	195	Q 1.2 S	0.6	0.6
F	4	244	FL 1.5 S	0.2	1.3
1	0	16	FL 1.5 S	0.3	1.2
0	5	5	FL 1.5 S	0.4	1.1
0	4	4	FL 1.5 S	0.5	1.0
2	0	32	FL 2 S	0.2	1.8
3	0	48	FL 2 S	0.3	1.7
4	0	64	FL 2 S	0.4	1.6
5	0	80	FL 2 S	0.5	1.5
6	0	96	FL 2 S	0.7	1.3
7	0	112	FL 2 S	0.8	1.2
1	2	18	ISO 2 S	1.0	1.0
8	0	128	FL 2.5 S	0.3	2.2
9	0	144	FL 2.5 S	0.5	2.0
D	6	214	FL 2.5 S	1.0	1.5
1	5	21	FL 3 S	0.2	2.8
A	0	160	FL 3 S	0.3	2.7
2	5	37	FL 3 S	0.4	2.6
B	0	176	FL 3 S	0.5	2.5
3	5	53	FL 3 S	0.6	2.4
C	0	192	FL 3 S	0.7	2.3
D	0	208	FL 3 S	1.0	2.0
2	2	34	ISO 3 S	1.5	1.5
5	4	84	OC 3 S	2.0	1.0
E	2	226	OC 3 S	2.5	0.5
4	6	70	OC 3.5 S	2.5	1.0
4	5	69	FL 4 S	0.2	3.8
5	5	85	FL 4 S	0.3	3.7
E	0	224	FL 4 S	0.4	3.6
F	0	240	FL 4 S	0.5	3.5
6	5	101	FL 4 S	0.6	3.4
0	1	1	FL 4 S	0.8	3.2
1	1	17	FL 4 S	1.0	3.0
2	1	33	FL 4 S	1.5	2.5
3	2	50	ISO 4 S	2.0	2.0
3	6	54	OC 4 S	2.5	1.5
F	2	242	OC 4 S	3.0	1.0
3	1	49	FL 4.3 S	1.3	3.0
8	5	133	FL 5 S	0.2	4.8
4	1	65	FL 5 S	0.3	4.7
5	1	81	FL 5 S	0.5	4.5
9	5	149	FL 5 S	0.9	4.1
6	1	97	FL 5 S	1.0	4.0

SWITCH		IR Controller	FLASH CODE	ON	OFF
A	B				
7	1	113	FL 5 S	1.5	3.5
4	2	66	ISO 5 S	2.5	2.5
8	2	130	LFL 5 S	2.0	3.0
0	3	3	OC 5 S	3.0	2.0
1	3	19	OC 5 S	4.0	1.0
2	3	35	OC 5 S	4.5	0.5
C	6	198	FL 6 S	0.2	5.8
B	5	181	FL 6 S	0.3	5.7
C	5	197	FL 6 S	0.4	5.6
8	1	129	FL 6 S	0.5	5.5
9	1	145	FL 6 S	0.6	5.4
A	1	161	FL 6 S	1.0	5.0
7	5	117	FL 6 S	1.2	4.8
B	1	177	FL 6 S	1.5	4.5
5	2	82	ISO 6 S	3.0	3.0
9	2	146	LFL 6 S	2.0	4.0
6	4	100	OC 6 S	4.0	2.0
3	3	51	OC 6 S	4.5	1.5
4	3	67	OC 6 S	5.0	1.0
A	4	164	FL 7 S	1.0	6.0
9	6	150	FL 7 S	2.0	5.0
5	6	86	OC 7 S	4.5	2.5
D	5	213	FL 7.5 S	0.5	7.0
C	1	193	FL 7.5 S	0.8	6.7
E	5	229	FL 8 S	0.5	7.5
B	4	180	FL 8 S	1.0	7.0
6	2	98	ISO 8 S	4.0	4.0
A	2	162	LFL 8 S	2.0	6.0
6	6	102	OC 8 S	5.0	3.0
B	2	178	LFL 8 S	3.0	5.0
F	5	245	FL 9 S	0.9	8.1
C	4	196	FL 9 S	1.0	8.0
7	6	118	OC 9 S	6.0	3.0
0	6	6	FL 10 S	0.2	9.8
1	6	22	FL 10 S	0.3	9.7
D	1	209	FL 10 S	0.5	9.5
2	6	38	FL 10 S	0.8	9.2
E	1	225	FL 10 S	1.0	9.0
1	4	20	FL 10 S	1.5	8.5
C	2	194	LFL 10 S	2.0	8.0
D	2	210	LFL 10 S	3.0	7.0
7	2	114	ISO 10 S	5.0	5.0
2	4	36	LFL 10 S	4.0	6.0
8	6	134	OC 10 S	6.0	4.0
5	3	83	OC 10 S	7.0	3.0
6	3	99	OC 10 S	7.5	2.5
F	1	241	FL 12 S	1.2	10.8
D	4	212	FL 12 S	2.5	9.5
3	4	52	LFL 12 S	2.0	10.0
0	2	2	FL 15 S	1.0	14.0
4	4	68	LFL 15 S	4.0	11.0
7	4	116	OC 15 S	10	5.0
A	6	166	LFL 20 S	2.0	18.0
E	4	228	FL 26 S	1.0	25.0

Appendix

Flash Codes

Sealite marine lanterns may be set to any of 310 IALA recommended flash settings which are user-adjustable onsite without the need for external devices.

SEALITE® code reference is listed by number of flashes

**For the latest version of this document visit www.sealite.com
or email info@sealite.com**

Symbols

FL	Flash followed by number Eg. FL 1 S, one flash every second
F	Fixed
Q	Quick flash
VQ	Very quick flash
OC	Occulting; greater period on than off
ISO	Isophase; equal period on and off
LFL	Long flash long
MO	Morse code () contains letter

For example, VQ (6) + LFL 10 S means 6 very quick flashes followed by a long flash, during a 10-second interval.

The amount of power your lantern draws through the night depends on the duty cycle, i.e. the amount of time on as a proportion to the timing cycle. For example, 0.5 seconds on and 4.5 seconds off equals a 10% duty cycle.

It is best to operate at the lowest duty cycle appropriate to the actual needs of the application.

Recommended Rhythm for Flashing Light - IALA Regions A and B

MARK DESCRIPTION	RHYTHM
Port Hand & Starboard Marks:	Any, other than Composite Group Flashing (2+1)
Preferred Channel Starboard:	Composite Group Flashing (2+1)
Preferred Channel Port:	Composite Group Flashing (2+1)
North Cardinal Mark:	Very quick or quick
East Cardinal Mark:	Very quick (3) every 5 seconds or quick (3) every 10 seconds
South Cardinal Mark:	Very quick (6) + long flash every 10 seconds or quick (6) + long flash every 15 seconds
West Cardinal Mark:	Very quick (9) every 10 seconds or quick (9) every 15 seconds
Isolated Danger Mark:	Group flashing (2)
Safe Water Mark:	Isophase, occulting, one long flash every 10 seconds or Morse Code "A"
Special Marks:	Any, other than those described for Cardinal, Isolated Danger or Safe Water Marks

SWITCH		IR Controller	FLASH CODE	ON	OFF	ON	OFF
A	B						
0	A	10	FL (2) 4 S	0.5	1.0	0.5	2.0
E	B	235	VQ (2) 4 S	0.2	1.0	0.2	2.6
1	A	26	FL (2) 4.5 S	0.3	1.0	0.3	2.9
2	A	42	FL (2) 4.5 S	0.4	1.0	0.4	2.7
3	A	58	FL (2) 4.5 S	0.5	1.0	0.5	2.5
F	9	249	FL (2) 5 S	0.2	0.8	0.2	3.8
2	C	44	FL (2) 5 S	0.2	1.2	0.2	3.4
4	A	74	FL (2) 5 S	0.4	0.6	0.4	3.6
0	7	7	FL (2) 5 S	0.5	1.0	0.5	3.0
1	7	23	FL (2) 5 S	1.0	1.0	1.0	2.0
9	B	155	Q (2) 5 S	0.3	0.7	0.3	3.7
2	9	41	Q (2) 5 S	0.5	0.5	0.5	3.5
5	A	90	FL (2) 5.5 S	0.4	1.4	0.4	3.3
7	8	120	FL (2) 6 S	0.3	0.6	1.0	4.1
A	A	170	FL (2) 6 S	0.3	0.9	0.3	4.5
6	A	106	FL (2) 6 S	0.3	1.0	0.3	4.4
7	A	122	FL (2) 6 S	0.4	1.0	0.4	4.2
9	9	153	FL (2) 6 S	0.5	1.0	0.5	4.0
2	8	40	FL (2) 6 S	0.8	1.2	0.8	3.2
3	7	55	FL (2) 6 S	1.0	1.0	1.0	3.0
3	9	57	Q (2) 6 S	0.3	0.7	0.3	4.7
A	9	169	FL (2) 7 S	1.0	1.0	1.0	4.0
7	B	123	FL (2) 8 S	0.4	0.6	2.0	5.0
8	A	138	FL (2) 8 S	0.4	1.0	0.4	6.2
4	7	71	FL (2) 8 S	0.5	1.0	0.5	6.0
8	8	136	FL (2) 8 S	0.8	1.2	2.4	3.6
5	7	87	FL (2) 8 S	1.0	1.0	1.0	5.0
4	C	76	OC (2) 8 S	3.0	2.0	1.0	2.0
5	C	92	OC (2) 8 S	5.0	1.0	1.0	1.0
F	B	251	VQ (2) 8 S	0.2	1.0	0.2	6.6
9	A	154	FL (2) 10 S	0.4	1.6	0.4	7.6
6	7	103	FL (2) 10 S	0.5	1.0	0.5	8.0
7	7	119	FL (2) 10 S	0.5	1.5	0.5	7.5
6	9	105	FL (2) 10 S	0.5	2.0	0.5	7.0
8	7	135	FL (2) 10 S	0.8	1.2	0.8	7.2
B	9	185	FL (2) 10 S	1.0	1.0	1.0	7.0
9	7	151	FL (2) 10 S	1.0	1.5	1.0	6.5
4	9	73	Q (2) 10 S	0.6	0.4	0.6	8.4
B	A	186	FL (2) 12 S	0.4	1.0	0.4	10.2
C	9	201	FL (2) 12 S	0.5	1.0	0.5	10.0
D	9	217	FL (2) 12 S	1.5	2.0	1.5	7.0
A	8	168	FL (2) 15 S	0.5	1.5	2.0	11.0
A	7	167	FL (2) 15 S	1.0	2.0	1.0	11.0
8	B	139	Q (2) 15 S	0.2	0.8	0.2	13.8
C	A	202	FL (2) 20 S	1.0	3.0	1.0	15.0
D	A	218	FL (2) 25 S	1.0	1.0	1.0	22.0

SWITCH		IR Controller	FLASH CODE	ON	OFF	ON	OFF	ON	OFF
A	B								
7	9	121	Q (3) 5 S	0.5	0.5	0.5	0.5	0.5	2.5
5	9	89	VQ (3) 5 S	0.2	0.3	0.2	0.3	0.2	3.8
0	C	12	VQ (3) 5 S	0.3	0.2	0.3	0.2	0.3	3.7
E	9	233	VQ (3) 5 S	0.3	0.3	0.3	0.3	0.3	3.5
3	C	60	FL (3) 6 S	0.5	1.0	0.5	1.0	0.5	2.5
2	B	43	FL (2+1) 6 S	0.3	0.4	0.3	1.2	0.3	3.5

SWITCH		IR Controller	FLASH CODE	ON	OFF	ON	OFF	ON	OFF
A	B								
A	B	171	Q (3) 6 S	0.3	0.7	0.3	0.7	0.3	3.7
F	A	250	FL (3) 8 S	0.5	1.0	0.5	1.0	0.5	4.5
0	B	11	FL (3) 9 S	0.3	1.0	0.3	1.0	0.3	6.1
B	7	183	FL (3) 9 S	0.8	1.2	0.8	1.2	0.8	4.2
B	8	184	FL (3) 10 S	0.3	0.7	0.3	0.7	0.9	7.1
C	8	200	FL (3) 10 S	0.4	0.6	0.4	0.6	1.2	6.8
C	B	203	FL (3) 10 S	0.5	0.5	0.5	0.5	0.5	7.5
C	7	199	FL (3) 10 S	0.5	1.5	0.5	1.5	0.5	5.5
D	B	219	FL (3) 10 S	0.6	0.6	0.6	0.6	0.6	7.0
D	7	215	FL (3) 10 S	1.0	1.0	1.0	1.0	1.0	5.0
3	8	56	FL (2+1) 10 S	0.5	0.7	0.5	2.1	0.5	5.7
8	9	137	OC (3) 10 S	5.0	1.0	1.0	1.0	1.0	1.0
B	B	187	Q (3) 10 S	0.3	0.7	0.3	0.7	0.3	7.7
D	8	216	FL (2 + 1) 10 S	0.5	0.5	0.5	0.5	1.5	6.5
1	B	27	FL (3) 12 S	0.5	1.5	0.5	1.5	0.5	7.5
E	A	234	FL (3) 12 S	0.5	2.0	0.5	2.0	0.5	6.5
E	7	231	FL (3) 12 S	0.8	1.2	0.8	1.2	0.8	7.2
B	6	182	FL (3) 12 S	1.0	1.0	1.0	3.0	1.0	5.0
4	8	72	FL (2+1) 12 S	0.8	1.2	0.8	2.4	0.8	6.0
5	8	88	FL (2+1) 12 S	1.0	1.0	1.0	4.0	1.0	4.0
1	8	24	FL (2+1) 13.5 S	1.0	1.0	1.0	4.0	1.0	5.5
F	7	247	FL (3) 15 S	0.3	1.7	0.3	1.7	0.3	10.7
9	D	157	FL (3) 15 S	0.4	1.0	0.4	1.0	0.4	11.8
0	8	8	FL (3) 15 S	0.5	1.5	0.5	1.5	0.5	10.5
F	8	248	FL (2+1) 15 S	0.6	0.3	0.6	0.3	1.4	11.8
0	9	9	FL (2+1) 15 S	0.7	0.5	0.7	0.5	1.9	10.7
1	9	25	FL (2+1) 15 S	0.7	0.7	0.7	0.7	2.1	10.1
6	8	104	FL (2+1) 15 S	1.0	2.0	1.0	5.0	1.0	5.0
1	C	28	VQ (3) 15 S	0.1	0.5	0.1	0.5	0.1	13.7
4	B	75	FL (3) 20 S	0.5	3.0	0.5	3.0	0.5	12.5
3	B	59	FL (3) 20 S	0.5	1.5	0.5	1.5	0.5	15.5
5	B	91	FL (3) 20 S	0.8	1.2	0.8	1.2	0.8	15.2
6	B	107	FL (3) 20 S	1.0	1.0	1.0	1.0	1.0	15.0

SWITCH		IR Controller	FLASH CODE	ON	OFF	ON	OFF	ON	OFF	ON	OFF
A	B										
B	F	191	VQ (4) 4 S	0.3	0.3	0.3	0.3	0.3	0.3	0.3	2.3
B	D	189	Q (4) 6 S	0.3	0.7	0.3	0.7	0.3	0.7	0.3	2.7
8	D	141	Q (4) 6 S	0.4	0.6	0.4	0.6	0.4	0.6	0.4	2.6
1	D	29	FL (4) 10 S	0.5	1.0	0.5	1.0	0.5	1.0	0.5	5.0
2	D	45	FL (4) 10 S	0.8	1.2	0.8	1.2	0.8	1.2	0.8	3.2
F	E	254	Q (4) 10 S	0.3	0.7	0.3	0.7	0.3	0.7	0.3	6.7
B	E	190	FL (4) 12 S	0.3	1.7	0.3	1.7	0.3	1.7	0.3	5.7
4	F	79	FL (4) 12 S	0.5	0.5	0.5	0.5	0.5	0.5	0.5	8.5
C	E	206	FL (4) 12 S	0.5	1.5	0.5	1.5	0.5	1.5	0.5	5.5
3	D	61	FL (4) 12 S	0.8	1.2	0.8	1.2	0.8	1.2	0.8	5.2
A	D	173	Q (4) 12 S	0.3	0.7	0.3	0.7	0.3	0.7	0.3	8.7
4	D	77	FL (4) 15 S	0.5	1.5	0.5	1.5	0.5	1.5	0.5	8.5
8	E	142	FL (4) 15 S	1.0	1.0	1.0	1.0	1.0	1.0	1.0	8.0
7	D	125	FL (4) 15 S	1.5	0.5	0.5	0.5	0.5	0.5	0.5	10.5
D	E	222	FL (4) 16 S	0.5	1.5	0.5	1.5	0.5	1.5	0.5	9.5
C	D	205	FL (4) 20 S	0.3	3.0	0.3	3.0	0.3	3.0	0.3	9.8
5	D	93	FL (4) 20 S	0.5	1.5	0.5	1.5	0.5	1.5	0.5	13.5
0	D	13	FL (4) 20 S	0.5	1.5	0.5	1.5	0.5	4.5	0.5	10.5
3	F	63	FL (4) 20 S	1.5	1.5	1.5	1.5	1.5	1.5	1.5	9.5
0	F	15	Q (4) 20 S	0.5	0.5	0.5	0.5	0.5	0.5	0.5	16.5
E	E	238	Q (4) 28 S	0.5	0.5	0.5	0.5	0.5	0.5	0.5	24.5
6	F	111	FL (4) 30 S	0.5	0.5	0.5	0.5	0.5	0.5	0.5	26.5

SWITCH		IR		FLASH CODE	ON	OFF	ON	OFF	ON	OFF	ON	OFF	ON	OFF	
A	B	Controller	IR												
D	D	221	Q (5) 7 S	0.3	0.7	0.3	0.7	0.3	0.7	0.3	0.7	0.3	0.7	0.3	2.7
E	D	237	Q (5) 10 S	0.3	0.7	0.3	0.7	0.3	0.7	0.3	0.7	0.3	0.7	0.3	5.7
E	8	232	FL (5) 12 S	0.5	1.5	0.5	1.5	0.5	1.5	0.5	1.5	0.5	1.5	0.5	3.5
5	F	95	FL (5) 20 S	0.5	0.5	0.5	0.5	0.5	0.5	0.5	0.5	0.5	0.5	0.5	15.5
9	F	159	FL (5) 20 S	0.8	1.2	0.8	1.2	0.8	1.2	0.8	1.2	0.8	1.2	0.8	11.2
9	E	158	FL (5) 20 S	1.0	1.0	1.0	1.0	1.0	1.0	1.0	1.0	1.0	1.0	1.0	11.0

SWITCH		IR		FLASH CODE	ON	OFF	ON	OFF	ON	OFF	ON	OFF	ON	OFF	
A	B	Controller	IR												
F	D	253	Q (6) 10 S	0.3	0.7	0.3	0.7	0.3	0.7	0.3	0.7	0.3	0.7	0.3	4.7
A	F	175	FL (6) 15 S	0.3	0.7	0.3	0.7	0.3	0.7	0.3	0.7	0.3	0.7	0.3	9.7
7	F	127	FL (6) 15 S	0.5	1.0	0.5	1.0	0.5	1.0	0.5	1.0	0.5	1.0	0.5	7.0

SWITCH		IR		FLASH CODE	ON	OFF	ON	OFF	ON	OFF	ON	OFF	ON	OFF	ON	OFF	
A	B	Controller	IR														
6	E	110	VQ (6) + LFL 10 S	0.2	0.3	0.2	0.3	0.2	0.3	0.2	0.3	0.2	0.3	0.2	0.3	2.0	5.0
7	E	126	VQ (6) + LFL 10 S	0.3	0.3	0.3	0.3	0.3	0.3	0.3	0.3	0.3	0.3	0.3	0.3	2.0	4.4
2	F	47	Q (6) + LFL 15 S	0.2	0.8	0.2	0.8	0.2	0.8	0.2	0.8	0.2	0.8	0.2	0.8	2.0	7.0
2	E	46	Q (6) + LFL 15 S	0.3	0.7	0.3	0.7	0.3	0.7	0.3	0.7	0.3	0.7	0.3	0.7	2.0	7.0
3	E	62	Q (6) + LFL 15 S	0.6	0.6	0.6	0.6	0.6	0.6	0.6	0.6	0.6	0.6	0.6	0.6	2.0	5.8
8	F	143	VQ (6) + LFL 15 S	0.3	0.3	0.3	0.3	0.3	0.3	0.3	0.3	0.3	0.3	0.3	0.3	2.0	9.4

SWITCH		IR		FLASH CODE	ON	OFF	ON	OFF	ON	OFF	ON	OFF	ON	OFF	ON	OFF	ON	OFF	
A	B	Controller	IR																
4	E	78	VQ (9) 10 S	0.2	0.3	0.2	0.3	0.2	0.3	0.2	0.3	0.2	0.3	0.2	0.3	0.2	0.3	0.2	5.8
5	E	94	VQ (9) 10 S	0.3	0.3	0.3	0.3	0.3	0.3	0.3	0.3	0.3	0.3	0.3	0.3	0.3	0.3	0.3	4.9
1	F	31	Q (9) 15 S	0.2	0.8	0.2	0.8	0.2	0.8	0.2	0.8	0.2	0.8	0.2	0.8	0.2	0.8	0.2	6.8
0	E	14	Q (9) 15 S	0.3	0.7	0.3	0.7	0.3	0.7	0.3	0.7	0.3	0.7	0.3	0.7	0.3	0.7	0.3	6.7
1	E	30	Q (9) 15 S	0.6	0.6	0.6	0.6	0.6	0.6	0.6	0.6	0.6	0.6	0.6	0.6	0.6	0.6	0.6	4.8

SWITCH		IR		FLASH CODE	ON	OFF	ON	OFF	ON	OFF	ON	OFF	
A	B	Controller	IR										
MORSE CODE () INDICATES LETTER													
7	8	120	MO (A) 6 S	0.3	0.6	1.0	4.1						
7	B	123	MO (A) 8 S	0.4	0.6	2.0	5.0						
8	8	136	MO (A) 8 S	0.8	1.2	2.4	3.6						
B	8	184	MO (U) 10 S	0.3	0.7	0.3	0.7	0.9	7.1				
C	8	200	MO (U) 10 S	0.4	0.6	0.4	0.6	1.2	6.8				
D	8	216	MO (U) 10 S	0.5	0.5	0.5	0.5	1.5	6.5				
9	8	152	MO (A) 10 S	0.5	0.5	1.5	7.5						
8	9	137	MO (D) 10 S	5.0	1.0	1.0	1.0	1.0	1.0				
A	8	168	MO (A) 15 S	0.5	1.5	2.0	11.0						
F	8	248	MO (U) 15 S	0.6	0.3	0.6	0.3	1.4	11.8				
0	9	9	MO (U) 15 S	0.7	0.5	0.7	0.5	1.9	10.7				
1	9	25	MO (U) 15 S	0.7	0.7	0.7	0.7	2.1	10.1				
7	D	125	MO (B) 15 S	1.5	0.5	0.5	0.5	0.5	0.5	0.5	10.5		



Sealite LED Light Warranty V2.2

Activating the Warranty

Upon purchase, the Sealite Pty Ltd warranty must be activated for recognition of future claims. To do this you need to register on-line. Please complete the Online Registration Form at:

www.sealite.com

Sealite Pty Ltd will repair or replace your LED light in the event of electronic failure for a period of up to three years from the date of purchase, as per the terms & conditions below.

Sealite Pty Ltd will repair or replace any ancillary or accessory products in the event of failure for a period of up to one year from the date of purchase, as per the terms & conditions below.

The unit(s) must be returned to Sealite freight prepaid.

Warranty Terms

1. Sealite Pty Ltd warrants that any Sealite marine products fitted with telemetry equipment including but not limited to AIS, GSM, GPS or RF ("Telemetry Products") will be free from defective materials and workmanship under normal and intended use, subject to the conditions hereinafter set forth, for a period of twelve (12) months from the date of purchase by the original purchaser.
2. Sealite Pty Ltd warrants that any BargeSafe™ Series of LED barge light products ("BargeSafe™ Products") will be free from defective materials and workmanship under normal and intended use, subject to the conditions hereinafter set forth, for a period of twelve (12) months from the date of purchase by the original purchaser.
3. Sealite Pty Ltd warrants that any LED area lighting products ("Area Lighting Products") but not including sign lighting products will be free from defective materials and workmanship under normal and intended use, subject to the conditions hereinafter set forth, for a period of twelve (12) months from the date of purchase by the original purchaser.
4. Sealite Pty Ltd warrants that any ancillary products and accessories, not mentioned in other clauses in this section, will be free from defective materials and workmanship under normal and intended use, subject to the conditions hereinafter set forth, for a period of twelve (12) months from the date of purchase by the original purchaser.
5. Sealite Pty Ltd warrants that any LED sign lighting products ("Sign Lighting Products") will be free from defective materials and workmanship under normal and intended use, subject to the conditions hereinafter set forth, for a period of three (3) years from the date of purchase by the original purchaser.
6. Sealite Pty Ltd warrants that any Sealite marine lighting products other than the Telemetry Products, BargeSafe™ Products, and Area Lighting Products ("Sealite Products") will be free from defective materials and workmanship under normal and intended use, subject to the conditions hereinafter set forth, for a period of three (3) years from the date of purchase by the original purchaser.
7. Sealite Pty Ltd will repair or replace, at Sealite's sole discretion, any Telemetry Products, BargeSafe™ Products, Area Lighting Products or Sealite Products found to be defective in material and workmanship in the relevant warranty period so long as the Warranty Conditions (set out below) are satisfied.
8. If any Telemetry Products, BargeSafe™ Products, Area Lighting Products or Sealite Products are fitted with a rechargeable battery, Sealite Pty Ltd warrants the battery will be free from defect for a period of one (1) year when used within original manufacturer's specifications and instructions.
9. Buoy products are covered by a separate 'Sealite Buoy Warranty'.

Warranty Conditions

This Warranty is subject to the following conditions and limitations;

1. The warranty is applicable to lanterns manufactured from 1/1/2009.
2. The warranty is void and inapplicable if:
 - a. the product has been used or handled other than in accordance with the instructions in the owner's manual and any other information or instructions provided to the customer by Sealite;
 - b. the product has been deliberately abused, or misused, damaged by accident or neglect or in being transported; or
 - c. the defect is due to the product being repaired or tampered with by anyone other than Sealite or



- authorised Sealite repair personnel.
3. The customer must give Sealite Pty Ltd notice of any defect with the product within 30 days of the customer becoming aware of the defect.
 4. Rechargeable batteries have a limited number of charge cycles and may eventually need to be replaced. Typical battery replacement period is 3-4 years. Long term exposure to high temperatures will shorten the battery life. Batteries used or stored in a manner inconsistent with the manufacturer's specifications and instructions shall not be covered by this warranty.
 5. No modifications to the original specifications determined by Sealite shall be made without written approval of Sealite Pty Ltd.
 6. Sealite lights can be fitted with 3rd party power supplies and accessories but are covered by the 3rd party warranty terms and conditions.
 7. The product must be packed and returned to Sealite Pty Ltd by the customer at his or her sole expense. Sealite Pty Ltd will pay return freight of its choice. A returned product must be accompanied by a written description of the defect and a photocopy of the original purchase receipt. This receipt must clearly list model and serial number, the date of purchase, the name and address of the purchaser and authorised dealer and the price paid by the purchaser. On receipt of the product, Sealite Pty Ltd will assess the product and advise the customer as to whether the claimed defect is covered by this warranty.
 8. Sealite Pty Ltd reserves the right to modify the design of any product without obligation to purchasers of previously manufactured products and to change the prices or specifications of any product without notice or obligation to any person.
 9. Input voltage shall not exceed those recommended for the product.
 10. Warranty does not cover damage caused by the incorrect replacement of battery in solar lantern models.
 11. This warranty does not cover any damage or defect caused to any product as a result of water flooding or any other acts of nature.
 12. There are no representations or warranties of any kind by Sealite or any other person who is an agent, employee, or other representative or affiliate of Sealite, express or implied, with respect to condition of performance of any product, their merchantability, or fitness for a particular purpose, or with respect to any other matter relating to any products.

Limitation of Liability

To the extent permitted by acts and regulations applicable in the country of manufacture, the liability of Sealite Pty Ltd under this Warranty will be, at the option of Sealite Pty Ltd, limited to either the replacement or repair of any defective product covered by this Warranty. Sealite will not be liable to Buyer for consequential damages resulting from any defect or deficiencies.

Limited to Original Purchaser

This Warranty is for the sole benefit of the original purchaser of the covered product and shall not extend to any subsequent purchaser of the product.

Miscellaneous

Apart from the specific warranties provided under this warranty, all other express or implied warranties relating to the above product is hereby excluded to the fullest extent allowable under law. The warranty does not extend to any lost profits, loss of good will or any indirect, incidental or consequential costs or damages or losses incurred by the purchaser as a result of any defect with the covered product.

Warrantor

Sealite Pty Ltd has authorised distribution in many countries of the world. In each country, the authorised importing distributor has accepted the responsibility for warranty of products sold by distributor. Warranty service should normally be obtained from the importing distributor from whom you purchased your product. In the event of service required beyond the capability of the importer, Sealite Pty Ltd will fulfil the conditions of the warranty. Such product must be returned at the owner's expense to the Sealite Pty Ltd factory, together with a photocopy of the bill of sale for that product, a detailed description of the problem, and any information necessary for return shipment.



Notes

Other Sealite Products Available



**Marine Lanterns
(1-19NM)**



**Monitoring
& Control Systems**



Bridge & Barge Lights



**Marine Buoys
(up to 3mt in diameter)**



Area Lighting



**Mooring Systems
& Accessories**